

FITTING INSTRUCTION

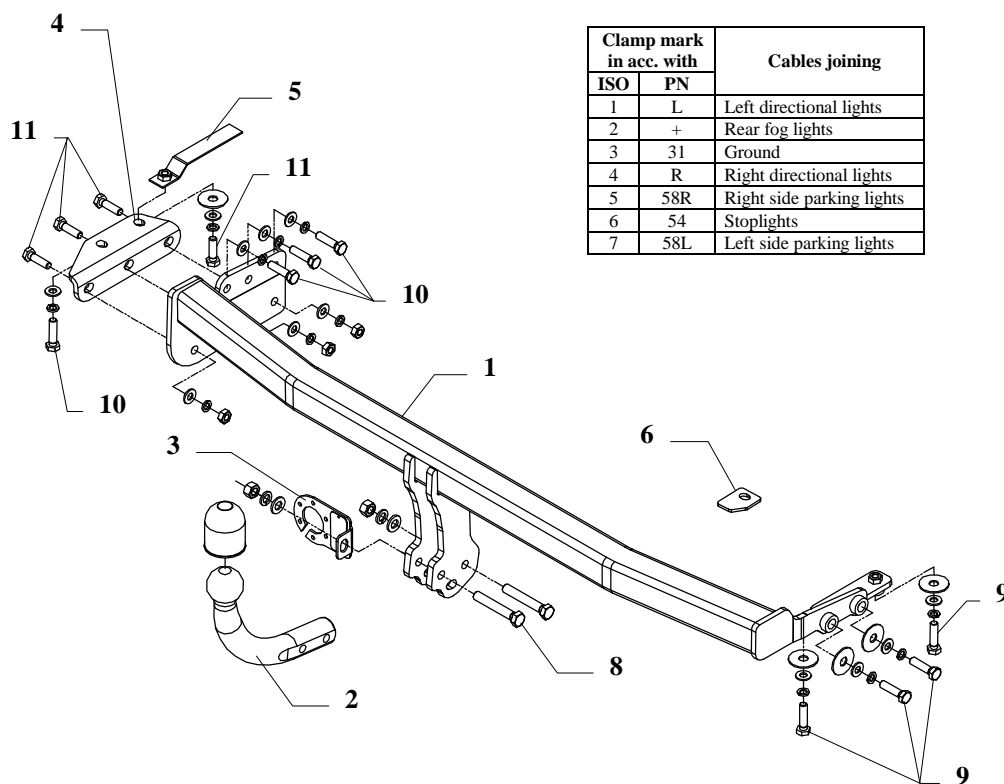

Clamp mark in acc. with		Cables joining
ISO	PN	
1	L	Left directional lights
2	+	Rear fog lights
3	31	Ground
4	R	Right directional lights
5	58R	Right side parking lights
6	54	Stoplights
7	58L	Left side parking lights

This towbar is designed to assembly in following cars:
NISSAN PRIMERA P 11 4/5 doors, produced since 10.1996 till 08.1999, catalogue no. **V54** and is prepared to tow trailers max total weight **1700 kg** and max vertical load **75 kg**.

From manufacturer

Thank you for buying our product. Their reliability has been confirmed in many tests. Reliability of towbar depends also on correct assembly and right operation. For this reasons we kindly ask to read carefully this instruction and apply to hints.

The towbar should be install in points described by a car producer.

The instruction of the assembly

1. Disassemble the bumper.
2. Lower the silencer and heat sheet.
3. Slide the element (pos. 6) to the right chassis members (to make smooth surface of the chassis members).
4. Slide the towbar bar handle to the right chassis member and fix it as it show the drawing.
5. Fix the left handle with the inside part of the chassis member using M10x1,25x40mm (pos. 10), then fix the element (pos. 4) with the chassis member using M10x1,25x40mm (pos. 10) and with the main bar of the towbar using M10x35 (pos. 11).
6. Reassemble the silencer using bolts M8x16mm (pos. 12).
7. Cut the bumper (fit it with the towbar).
8. Fix tow-ball (pos. 2) and socket plate (pos. 3) using bolts M12x75mm (pos. 8) from accessories.
9. Tighten all nuts and bolts according to the torque shown in the table.
10. Connect to the electric wires according to the instructions of the car.
11. Complete the paint cover of towbar (during the mounting paint cover could be destroyed).

Torque settings for nuts and bolts (8,8):	
M 8 - 25 Nm	M 10 - 55 Nm
M 12 - 85 Nm	M 14 - 135 Nm











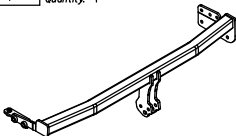
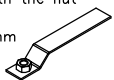





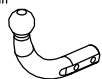

NOTE

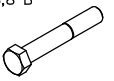
After install the towbar you should get adequate note in registration book (at authorised service station).The car should be equipped with:

- Indicators
- Tow mirrors

After 1000km check all bolts and nuts. The ball of towbar must be always kept clear and conserve with a grease.

Towbar accessories:

Pos. 1	Name: Main bar Quantity: 1 	Pos. 5	Name: Jib with the nut Quantity: 1 Dim.: 150x25x2 mm 	Pos. 10	Name: Bolt 8,8 B Quantity: 4 Dim.: M10x1,25x40mm 	Pos. 16	Name: Plain washer Quantity: 12 Dim.: Ø 10,5 mm 
		Pos. 6	Name: Plate bar Quantity: 1 Dim.: 49x37x4 mm 	Pos. 11	Name: Bolt 8,8 B Quantity: 4 Dim.: M10x35mm 	Pos. 17	Name: Plain washer Quantity: 2 Dim.: Ø 8,5 mm 
Pos. 2	Name: Tow ball Quantity: 1 	Pos. 7	Name: Washer Quantity: 5 Dim.: Ø40x12x2mm 	Pos. 12	Name: Bolt 8,8 B Quantity: 2 Dim.: M8x16mm 	Pos. 18	Name: Spring washer Quantity: 2 Dim.: Ø 12,2 mm 
Pos. 3	Name: Socket plate Quantity: 1 	Pos. 8	Name: Bolt 8,8 B Quantity: 2 Dim.: M12x75mm 	Pos. 13	Name: Nut 8 B Quantity: 2 Dim.: M12 	Pos. 19	Name: Spring washer Quantity: 12 Dim.: Ø 10,2 mm 
Pos. 4	Name: Left bracket Quantity: 1 Dim.: 192x57x42 mm 	Pos. 9	Name: Bolt 8,8 B Quantity: 4 Dim.: M10x40mm 	Pos. 14	Name: Nut 8 B Quantity: 3 Dim.: M10 	Pos. 20	Name: Spring washer Quantity: 2 Dim.: Ø 8,2 mm 
		Pos. 15	Name: Plain washer Quantity: 2 Dim.: Ø 13 mm 	Pos. 21	Name: Ball cover Quantity: 1 		



PPUH AUTO-HAK S. J.

Produkcja Haków Holowniczych
Henryk & Zbigniew Nejman
76-200 SŁUPSK ul. Słoneczna 16K
tel/fax (059) 8-414-414; 8-414-413
E-mail: office@autohak.com.pl
www.autohak.com.pl

Towing hitch (without electrical set)

Class: **A50-X** Cat. no. **V54**

Designed for:

Manufacturer: **NISSAN**

Model: **PRIMERA**

Type: **P11 4/5 doors**

produced since 10.1996 till 08.1999

Technical data:

D-value: 8,60 kN

maximum trailer weight: **1700 kg**

maximum vertical cup load: **75 kg**

Approval number acc. to regulations EKG/ONZ 55.01: E20-55R-01 0923

Foreword

This towbar is designed according to rules of safety traffic regulations. The towing hitch is a safety component and can be install only by qualified personnel. Any alteration or conversion of the towing hitch is prohibited and would lead to cancellation of design certification. Remove insulating compound and underseal from vehicle (if present) in the area of the matting surfaces of the towing hitch.

The vehicle manufacturer's specifications regarding trailer load and max. vertical cup load are decisive for driving, and values for the towing hitch cannot be exceeded.

D-value formula:

$$\frac{\text{Max trailer weight [kg]} \times \text{Max vehicle weight [kg]}}{\text{Max trailer weight [kg]} + \text{Max vehicle weight [kg]}} \times \frac{9,81}{1000} = D \text{ [kN]}$$